

CONFIGURATIONS / BEISPIEL ANORDNUNG / CONFIGURATIONS

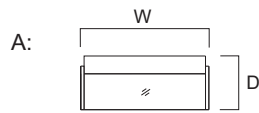

Cable-way only on the left side:
Kabeldurchlass nur an der Linken Seite:
Obturbateur seulement à gauche: 1x ø 80mm

INDEX / SYMBOL	DIMENSIONS / ABMESSUNGEN / DIMENSIONS (mm)		
A	W	D	H
LVC96L	900	458	1105

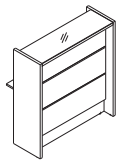
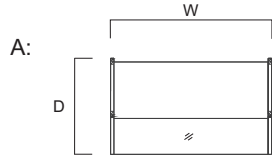
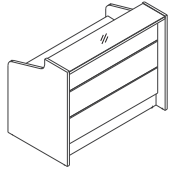

INDEX / SYMBOL	DIMENSIONS / ABMESSUNGEN / DIMENSIONS (mm)		
A	W	D	H
LVC95L	900	801	1105
LVC75L	1346	801	1105
LVC76L	1646	801	1105
LVC77L	2346	801	1105

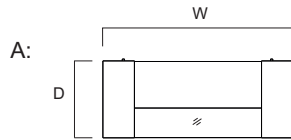
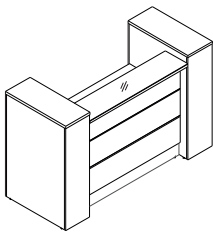

Please note: contains LVD10 2 pcs
Achtung: enthält LVD10 2 Stück
Attention: contient LVD10 2 pieces

INDEX / SYMBOL	DIMENSIONS / ABMESSUNGEN / DIMENSIONS (mm)		
A	W	D	H
LVC01L	1930	798	1200
LVC02L	2230	798	1200
LVC03L	2930	798	1200

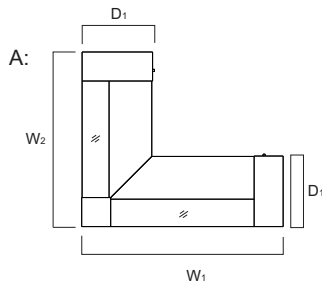
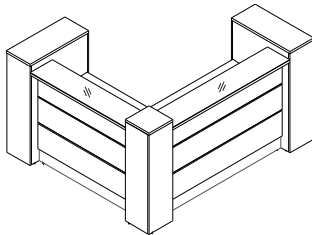

Please note: contains LVD10 2 pcs
Achtung: enthält LVD10 2 Stück
Attention: contient LVD10 2 pieces

INDEX / SYMBOL	DIMENSIONS / ABMESSUNGEN / DIMENSIONS (mm)			
A	W ₁	W ₂	D ₁	H
LVC10L	1930	1930	798	1200
LVC11L	1930	2230	798	1200
LVC12L	1930	2930	798	1200
LVC13L	2230	1930	798	1200
LVC14L	2230	2230	798	1200
LVC15L	2230	2930	798	1200
LVC16L	2930	1930	798	1200
LVC17L	2930	2230	798	1200
LVC18L	2930	2930	798	1200

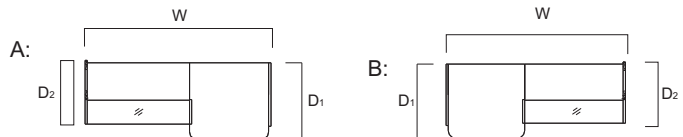
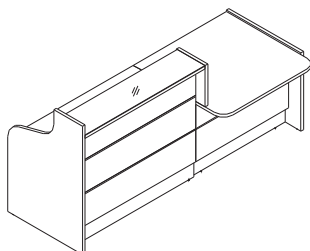

INDEX / SYMBOL	DIMENSIONS / ABMESSUNGEN / DIMENSIONS (mm)				
A	B	W	D ₁	D ₂	H
LVC19L	LVC20L	2346	968	801	1105
LVC21L	LVC22L	2646	968	801	1105
LVC23L	LVC24L	3346	968	801	1105

CONFIGURATIONS / BEISPIEL ANORDNUNG / CONFIGURATIONS

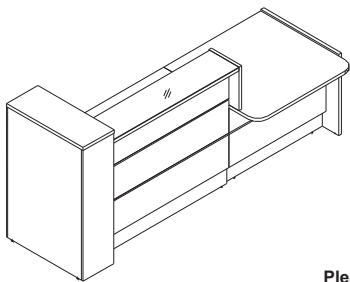

Please note: contains LVD10 1 pc
Achtung: enthält LVD10 1 Stück
Attention: contient LVD10 1 piece

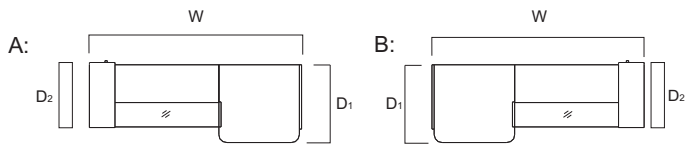

INDEX / SYMBOL		DIMENSIONS / ABMESSUNGEN / DIMENSIONS (mm)			
A	B	W	D ₁	D ₂	H
LVC41L	LVC42L	2638	968	798	1200
LVC43L	LVC44L	2938	968	798	1200
LVC45L	LVC46L	3638	968	798	1200

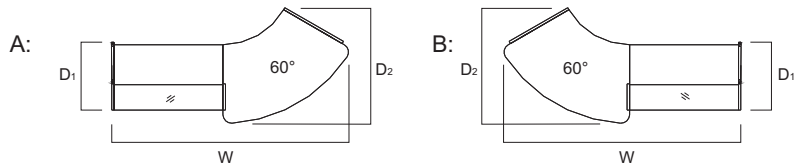
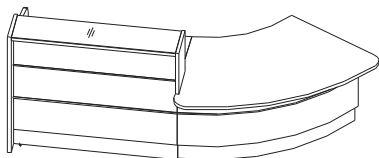

INDEX / SYMBOL		DIMENSIONS / ABMESSUNGEN / DIMENSIONS (mm)			
A	B	W	D ₁	D ₂	H
LVC88L	LVC89L	2803	801	1341	1105
LVC91L	LVC92L	3103	801	1341	1105
LVC93L	LVC94L	3803	801	1341	1105

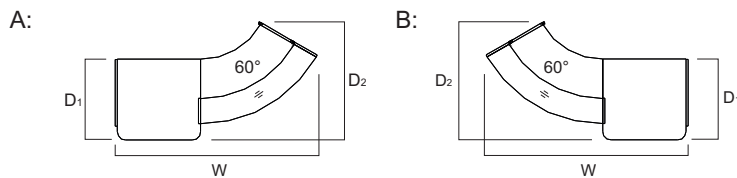
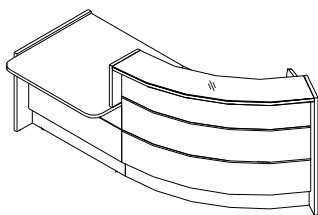

INDEX / SYMBOL		DIMENSIONS / ABMESSUNGEN / DIMENSIONS (mm)			
A	B	W	D ₁	D ₂	H
LVC84L	LVC85L	2427	968	1418	1105

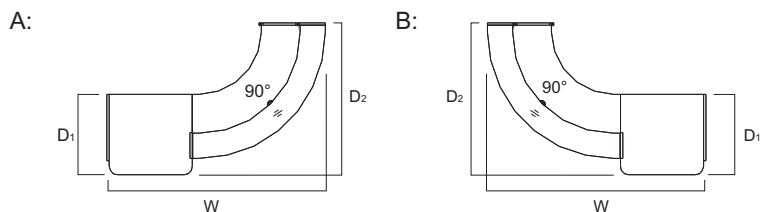
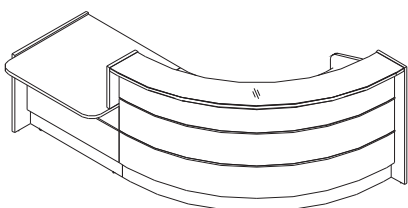

INDEX / SYMBOL		DIMENSIONS / ABMESSUNGEN / DIMENSIONS (mm)			
A	B	W	D ₁	D ₂	H
LVC86L	LVC87L	2629	968	1824	1105

CONFIGURATIONS / BEISPIEL ANORDNUNG / CONFIGURATIONS

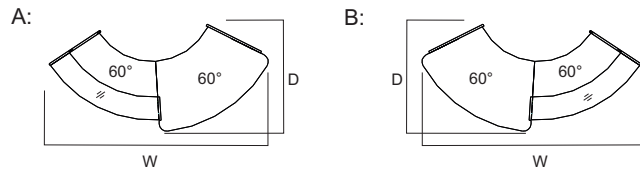
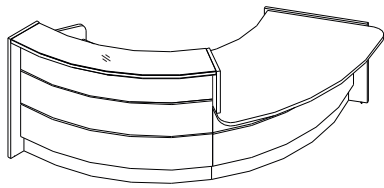

INDEX / SYMBOL		DIMENSIONS / ABMESSUNGEN / DIMENSIONS (mm)		
A	B	W	D	H
LVC30L	LVC31L	2888	1380	1105

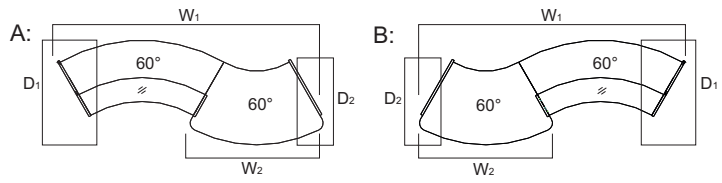
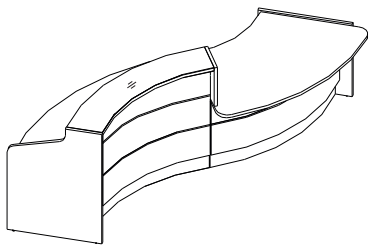

INDEX / SYMBOL		DIMENSIONS / ABMESSUNGEN / DIMENSIONS (mm)				
A	B	W ₁	W ₂	D ₁	D ₂	H
LVC32L	LVC33L	3360	1675	1321	1079	1105

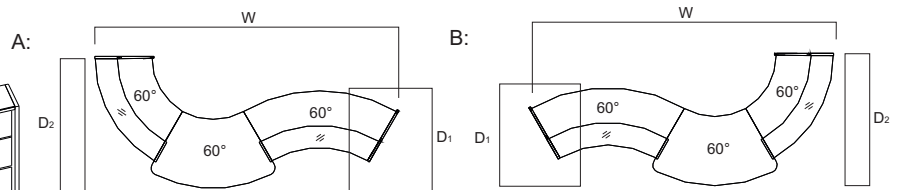
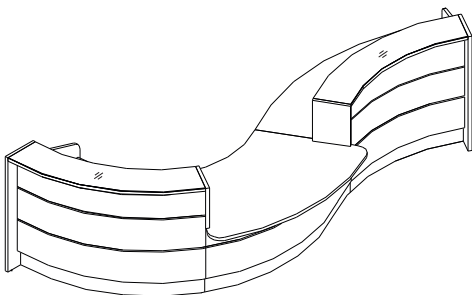

INDEX / SYMBOL		DIMENSIONS / ABMESSUNGEN / DIMENSIONS (mm)			
A	B	W	D ₁	D ₂	H
LVC34L	LVC35L	4127	1321	1788	1105

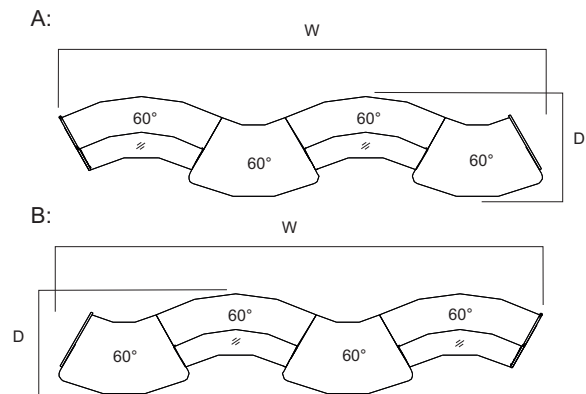
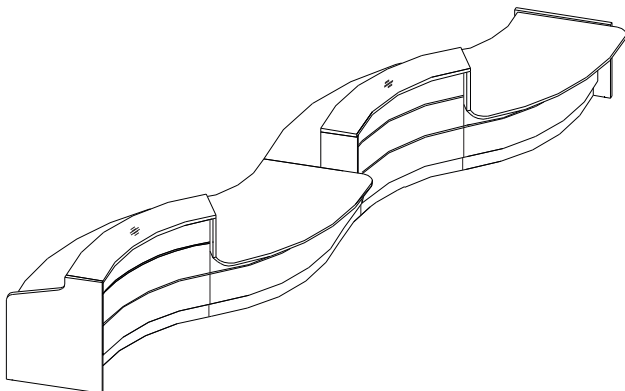

INDEX / SYMBOL		DIMENSIONS / ABMESSUNGEN / DIMENSIONS (mm)		
A	B	W	D	H
LVC36L	LVC37L	6260	1321	1105

CONFIGURATIONS / BEISPIEL ANORDNUNG / CONFIGURATIONS

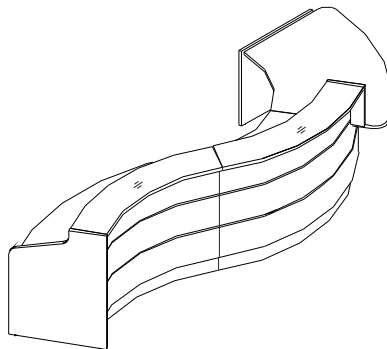

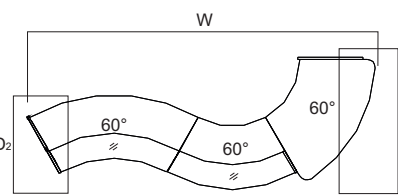
A: 

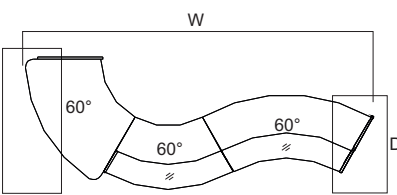
B: 

INDEX / SYMBOL		DIMENSIONS / ABMESSUNGEN / DIMENSIONS (mm)			
A	B	W	D ₁	D ₂	H
LVC38L	LVC39L	4280	1627	1161	1105

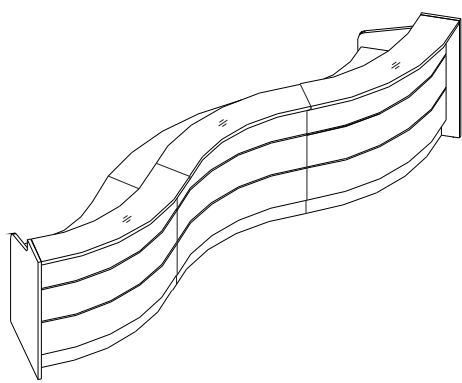

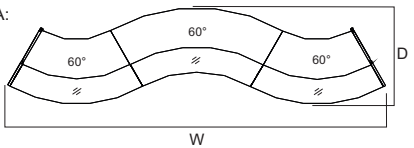
A: 

INDEX / SYMBOL	DIMENSIONS / ABMESSUNGEN / DIMENSIONS (mm)		
A	W	D	H
LVC50L	4552	1161	1105

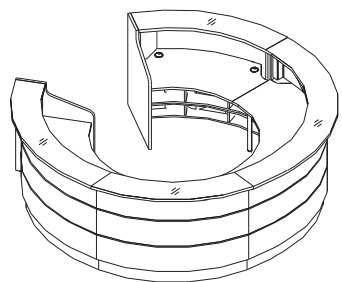

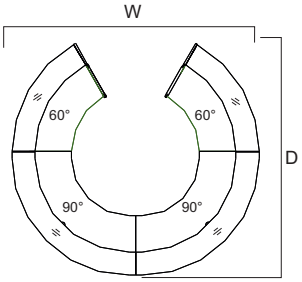
A: 

INDEX / SYMBOL	DIMENSIONS / ABMESSUNGEN / DIMENSIONS (mm)		
A	W	D	H
LVC51L	3202	3004	1105

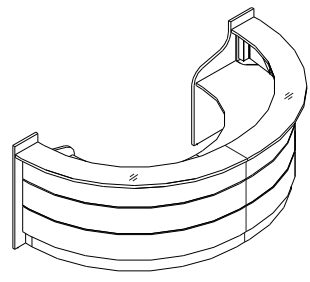

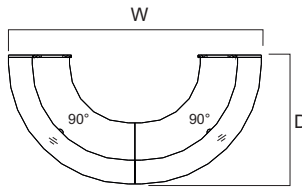
A: 

INDEX / SYMBOL	DIMENSIONS / ABMESSUNGEN / DIMENSIONS (mm)		
A	W	D	H
LVC52L	3204	1629	1105

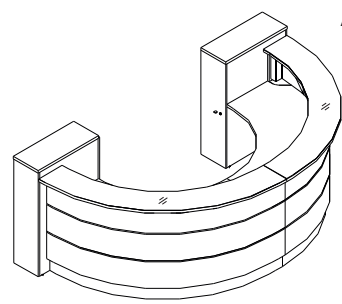

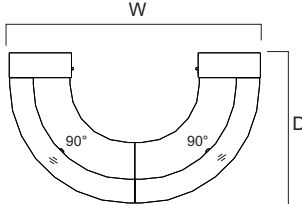
A: 

INDEX / SYMBOL	DIMENSIONS / ABMESSUNGEN / DIMENSIONS (mm)		
A	W	D	H
LVC61L	3216	1921	1200

Please note: contains LVD10 2 pcs
Achtung: enthält LVD10 2 Stück
Attention: contient LVD10 2 pieces

CONFIGURATIONS / BEISPIEL ANORDNUNG / CONFIGURATIONS

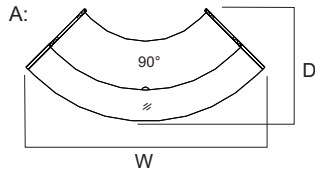
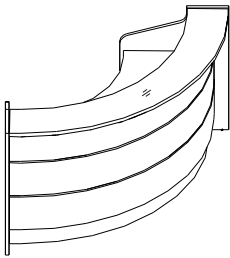

INDEX / SYMBOL	DIMENSIONS / ABMESSUNGEN / DIMENSIONS (mm)		
A	W	D	H
LVC53L	2302	1090	1105

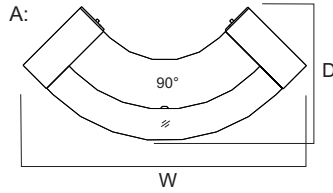
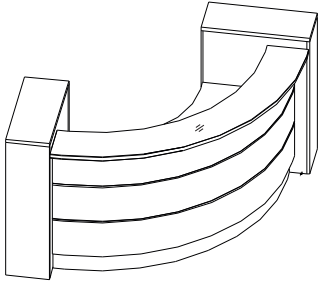

INDEX / SYMBOL	DIMENSIONS / ABMESSUNGEN / DIMENSIONS (mm)		
A	W	D	H
LVC73L	2715	1280	1200

Please note: contains LVD10 2 pcs
Achtung: enthält LVD10 2 Stück
Attention: contient LVD10 2 pieces

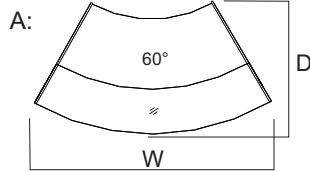
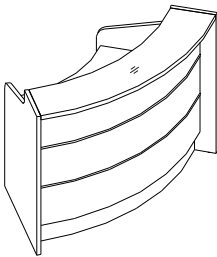

INDEX / SYMBOL	DIMENSIONS / ABMESSUNGEN / DIMENSIONS (mm)		
A	W	D	H
LVC54L	1652	919	1105

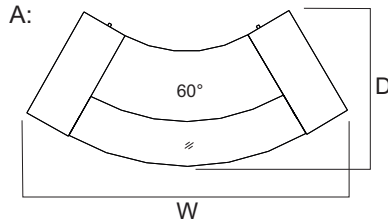
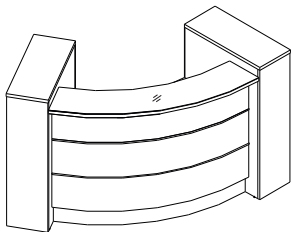

INDEX / SYMBOL	DIMENSIONS / ABMESSUNGEN / DIMENSIONS (mm)		
A	W	D	H
LVC74L	2162	1042	1200

Please note: contains LVD10 2 pcs
Achtung: enthält LVD10 2 Stück
Attention: contient LVD10 2 pieces

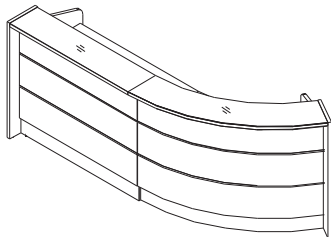
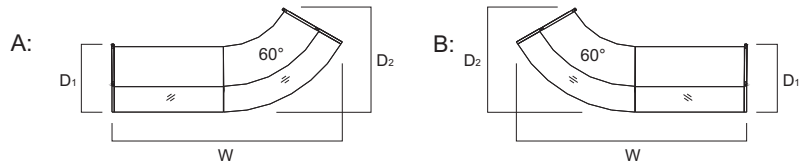

INDEX / SYMBOL		DIMENSIONS / ABMESSUNGEN / DIMENSIONS (mm)			
A	B	W	D ₁	D ₂	H
LVC78L	LVC79L	2718	801	1225	1105
LVC80L	LVC81L	3018	801	1225	1105
LVC82L	LVC83L	3718	801	1225	1105

CONFIGURATIONS / BEISPIEL ANORDNUNG / CONFIGURATIONS

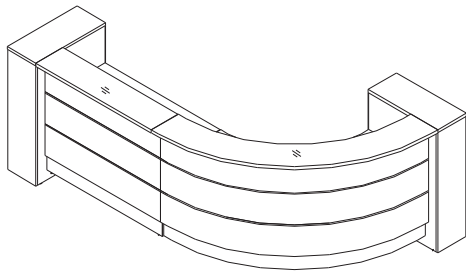

Please note: contains LVD10 2 pcs
Achtung: enthält LVD10 2 Stück
Attention: contient LVD10 2 pieces

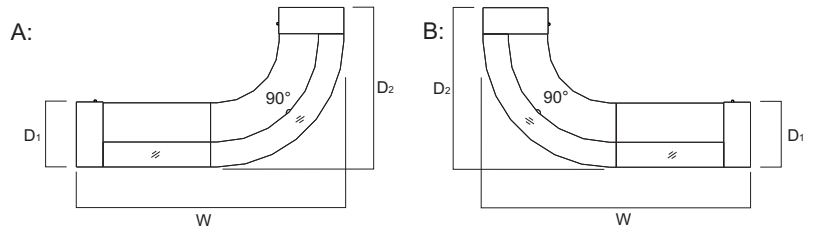

INDEX / SYMBOL		DIMENSIONS / ABMESSUNGEN / DIMENSIONS (mm)			
A	B	W	D ₁	D ₂	H
LVC55L	LVC56L	3212	798	1921	1200
LVC57L	LVC58L	3512	798	1921	1200
LVC59L	LVC60L	4213	798	1921	1200

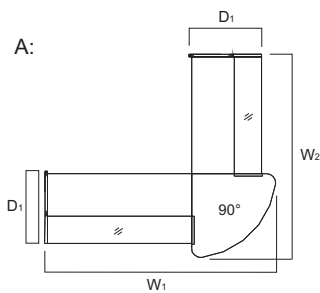
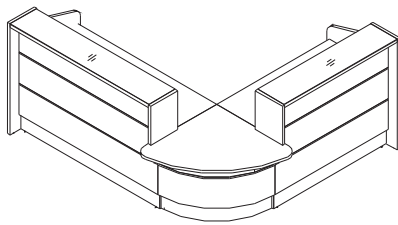

INDEX / SYMBOL	DIMENSIONS / ABMESSUNGEN / DIMENSIONS (mm)			
A	W ₁	W ₂	D ₁	D ₂
LVC101L	2243	2243	801	1105
LVC102L	2243	2543	801	1105
LVC103L	2243	3243	801	1105
LVC104L	2543	2243	801	1105
LVC105L	2543	2543	801	1105
LVC106L	2543	3243	801	1105
LVC107L	3243	2243	801	1105
LVC108L	3243	2543	801	1105
LVC109L	3243	3243	801	1105

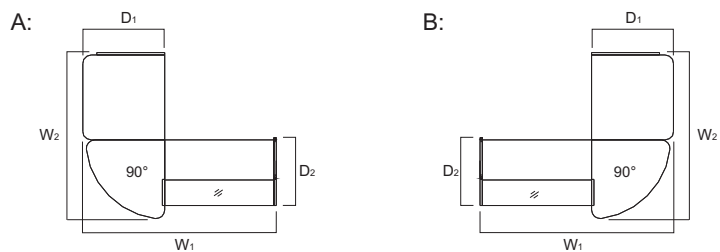
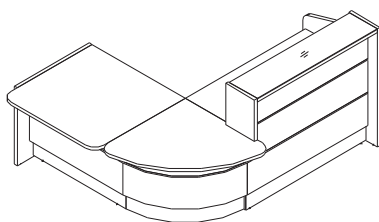

INDEX / SYMBOL		DIMENSIONS / ABMESSUNGEN / DIMENSIONS (mm)				
A	B	W ₁	W ₂	D ₁	D ₂	H
LVC110L	LVC111L	2286	1953	968	801	1105
LVC112L	LVC113L	2586	1953	968	801	1105
LVC114L	LVC115L	3286	1953	968	801	1105

CONFIGURATIONS / BEISPIEL ANORDNUNG / CONFIGURATIONS

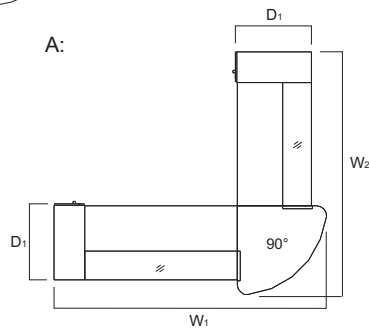
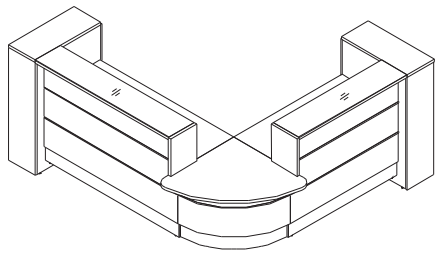

Please note: contains LVD10 2 pcs
Achtung: enthält LVD10 2 Stück
Attention: contient LVD10 2 pieces

INDEX / SYMBOL	DIMENSIONS / ABMESSUNGEN / DIMENSIONS (mm)			
A	W ₁	W ₂	D ₁	H
LVC116L	2535	2535	798	1200
LVC117L	2535	2835	798	1200
LVC118L	2535	3535	798	1200
LVC119L	2835	2535	798	1200
LVC120L	2835	2835	798	1200
LVC121L	2835	3535	798	1200
LVC122L	3535	2535	798	1200
LVC123L	3535	2835	798	1200
LVC124L	3535	3535	798	1200

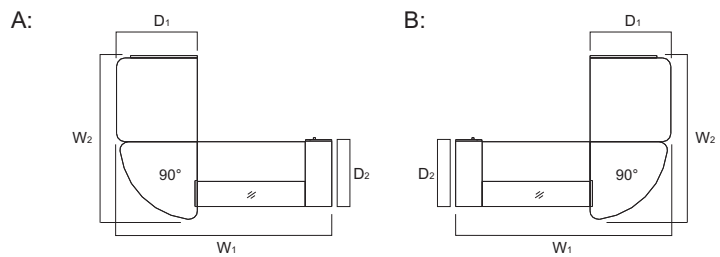
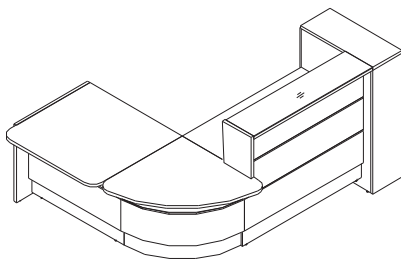

Please note: contains LVD10 1 pc
Achtung: enthält LVD10 1 Stück
Attention: contient LVD10 1 piece

INDEX / SYMBOL		DIMENSIONS / ABMESSUNGEN / DIMENSIONS (mm)				
A	B	W ₁	W ₂	D ₁	D ₂	H
LVC125L	LVC126L	2578	1953	968	798	1200
LVC127L	LVC128L	2878	1953	968	798	1200
LVC129L	LVC130L	3578	1953	968	798	1200

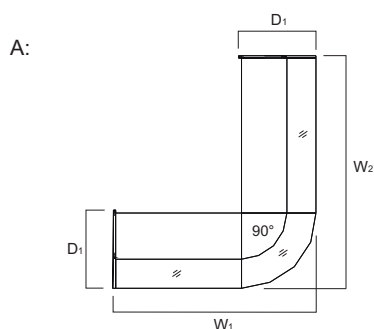
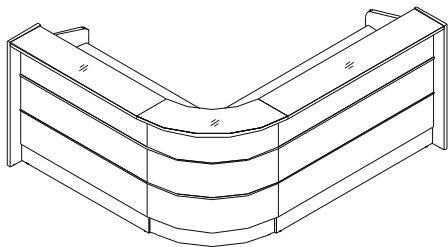

INDEX / SYMBOL	DIMENSIONS / ABMESSUNGEN / DIMENSIONS (mm)			
A	W ₁	W ₂	D ₁	H
LVC131L	2091	2091	801	1105
LVC132L	2091	2391	801	1105
LVC133L	2091	3091	801	1105
LVC134L	2391	2091	801	1105
LVC135L	2391	2391	801	1105
LVC136L	2391	3091	801	1105
LVC137L	3091	2091	801	1105
LVC138L	3091	2391	801	1105
LVC139L	3091	3091	801	1105

CONFIGURATIONS / BEISPIEL ANORDNUNG / CONFIGURATIONS

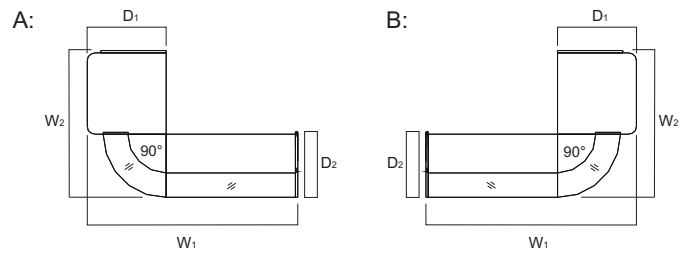
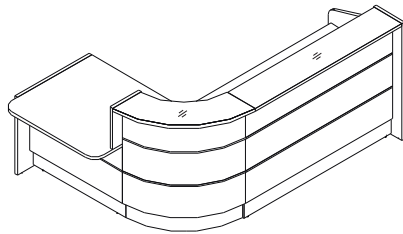

INDEX / SYMBOL		DIMENSIONS / ABMESSUNGEN / DIMENSIONS (mm)				
A	B	W ₁	W ₂	D ₁	D ₂	H
LVC140L	LVC141L	2286	1801	968	801	1105
LVC142L	LVC143L	2586	1801	968	801	1105
LVC144L	LVC145L	3286	1801	968	801	1105

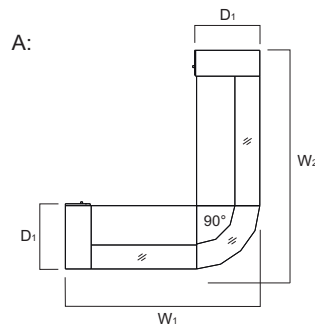
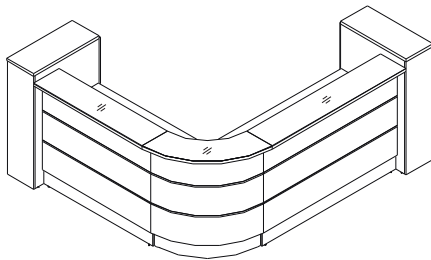

Please note: contains LVD10 2 pcs
Achtung: enthält LVD10 2 Stück
Attention: contient LVD10 2 pieces

INDEX / SYMBOL	DIMENSIONS / ABMESSUNGEN / DIMENSIONS (mm)			
A	W ₁	W ₂	D ₁	H
LVC146L	2383	2383	798	1200
LVC147L	2383	2681	798	1200
LVC148L	2383	3383	798	1200
LVC149L	2681	2383	798	1200
LVC150L	2681	2681	798	1200
LVC151L	2681	3383	798	1200
LVC152L	3383	2383	798	1200
LVC153L	3383	2681	798	1200
LVC154L	3383	3383	798	1200

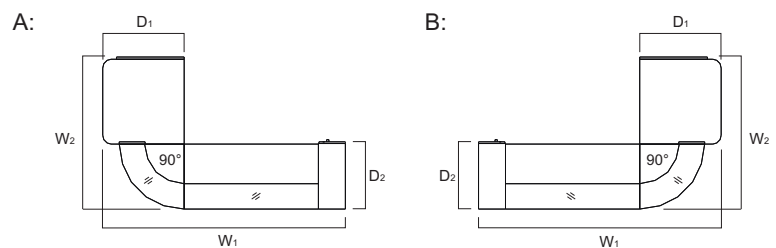
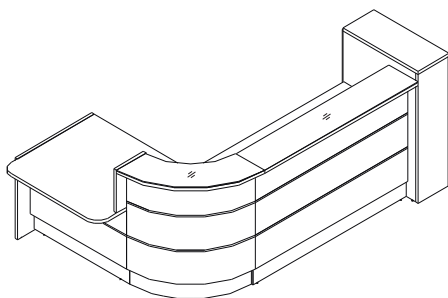

Please note: contains LVD10 1 pc
Achtung: enthält LVD10 1 Stück
Attention: contient LVD10 1 piece

INDEX / SYMBOL		DIMENSIONS / ABMESSUNGEN / DIMENSIONS (mm)				
A	B	W ₁	W ₂	D ₁	D ₂	H
LVC155L	LVC156L	2578	1801	968	798	1200
LVC157L	LVC158L	2878	1801	968	798	1200
LVC159L	LVC160L	3578	1801	968	798	1200

PRODUCT ILLUSTRATION OBJEKTANSICHT UND SKIZZE VUE DE PRODUIT	DIMENSIONS / ABMESSUNGEN / DIMENSIONS (mm)			INDEX / SYMBOL
	width/Breite/ largeur a / a'	depth/Tiefe/ profondeur b / b'	height/Höhe/ hauteur h	

STRAIGHT UNITS / GERADE BESTANDTEIL / PLATEAUX DROITS

	844	772	1105	LV09L
	1290	772	1105	LV13L
	1590	772	1105	LV16L
	2290	772	1105	LV23L
	1290	772	1105	LVP13L
	1590	772	1105	LVP16L
	2290	772	1105	LVP23L
	1290	772	1105	LVL13L
	1590	772	1105	LVL16L
	2290	772	1105	LVL23L
	1000	968	720	LVU11L

LED: Illumination / Beleuchtung / Illumination

Elements LVP and LVL require a supporting metal leg NK41 / Zum LVL und LVP zusätzlich den Stützfuß NK41 bestellen. /

LVL et LVP ont besoin d'un pied NK41

CURVED UNITS / BOGEN BESTENDTEILE / PLANS D'ANGLE

	2072	772	1105	LVC62L
	1600	772	1105	LVC64L
	1657	935	720	LVC66L
	1226	938	720	LVC68L

Please note: Units shown above are not freestanding. / Diese Thekenteile sind keine freistehende Elemente. /

Les éléments ci-dessus ne sont pas indépendants.

PRODUCT ILLUSTRATION OBJEKTANSICHT UND SKIZZE VUE DE PRODUIT	DIMENSIONS / ABMESSUNGEN / DIMENSIONS (mm)			INDEX / SYMBOL	REMARKS BEMERKUNGEN REMARQUES
	width/Breite/ largeur a / a'	depth/Tiefe/ profondeur b / b'	height/Höhe/ hauteur h		

CURVED UNITS / BOGEN BESTENDTEILE / PLANS D'ANGLE

	1092	772	1105	LVC70L	
	1600	1600	1105	LVC90L	

Please note: Units shown above are not freestanding. / Diese Thekenteile sind keine freistehende Elemente.
/ Les éléments ci-dessus ne sont pas indépendants.

COMPONENTS / BESTANDTEILE / ELEMENTS

	320	320	1200	LV10	- corner unit - Würfel Fuß - monobloc fermé
	320	780	1200	LVP10	- end unit with cupboard, right - Seitenschrank - monobloc à étagères, droit
	320	780	1200	LVL10	- end unit with cupboard, left - Seitenschrank - monobloc à étagères, gauche
	312	18	1156	LVD10	- door for LVP10 and LVL10 - Tür mit Verschluss zum LVP10 und LVL10 - porte pour LVP10 et LVL10

POSSIBLE CONFIGURATIONS / BEISPIEL ANOGDUNG / EXEMPLES DE CONFIGURATIONS

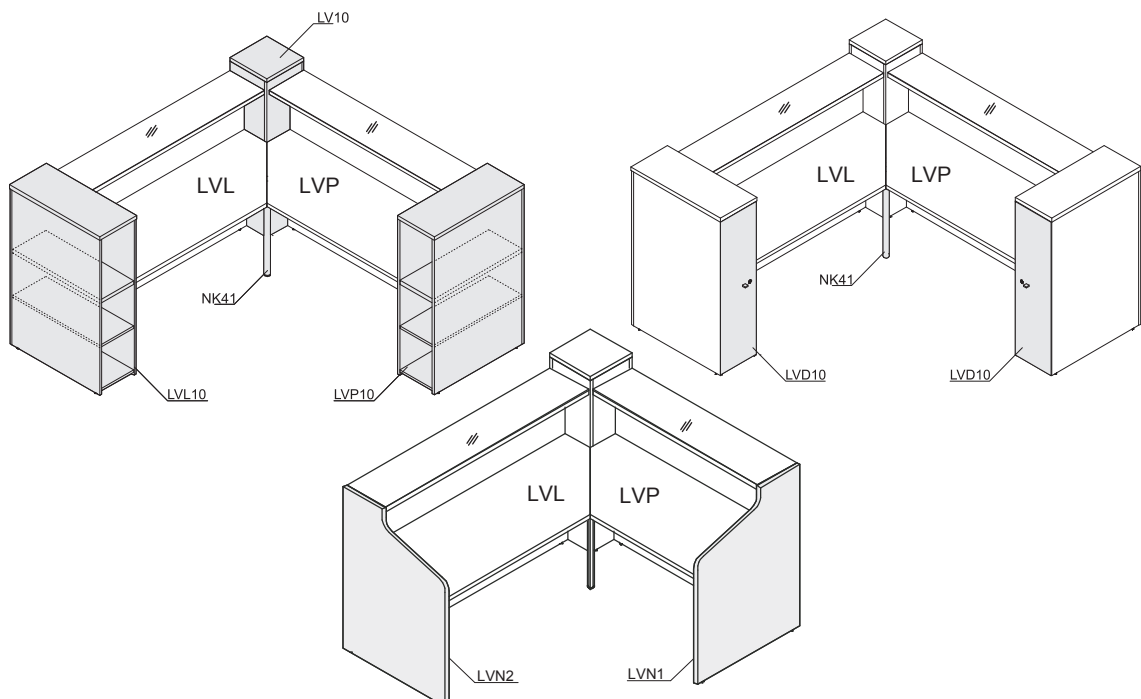

PRODUCT ILLUSTRATION OBJEKTANSICHT UND SKIZZE VUE DE PRODUIT	DIMENSIONS / ABMESSUNGEN / DIMENSIONS (mm)			INDEX / SYMBOL	REMARKS BEMERKUNGEN REMARQUES
	width/Breite/ largeur a / a'	depth/Tiefe/ profondeur b / b'	height/Höhe/ hauteur h		

COMPONENTS / BESTANDTEILE / ELEMENTS

	28	801	1105	LVN1	- side panel for high units, right - Wangenfuß, Recht - pied coté droit des éléments hauts
	28	801	1105	LVN2	- side panel for high units, left - Wangenfuß, Links - pied coté gauche des éléments hauts
	28	308	370	LVN3	- right upper side panel - Endungselent, Recht - élément de finition de la rehausse, droit
	28	308	370	LVN4	- left upper side panel - Endungselent, Links - élément de finition de la rehausse, gauche
	28	801	735	LVN5	- right lower side panel - Wangenfuß niedrig, Recht - pied de la banquette pour les handicapés, droit
	28	801	735	LVN6	- left lower side panel - Wangenfuß niedrig, Links - pied de la banquette pour les handicapés, gauche
	∅40		690	NK41	- supporting leg - Stützfuß - pied de support 09-aluminium

POSSIBLE CONFIGURATIONS / BEISPIEL ANOGDUNG / EXEMPLES DE CONFIGURATIONS

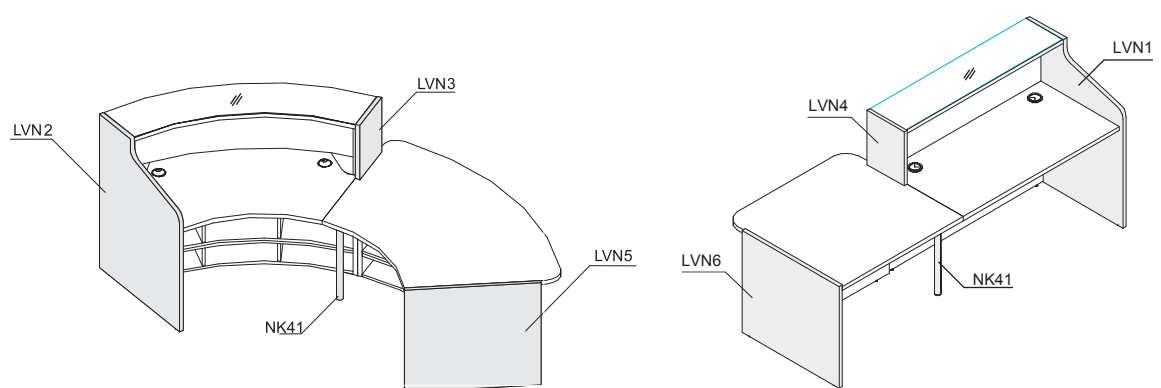

* NK41 - required on all connections of receptions

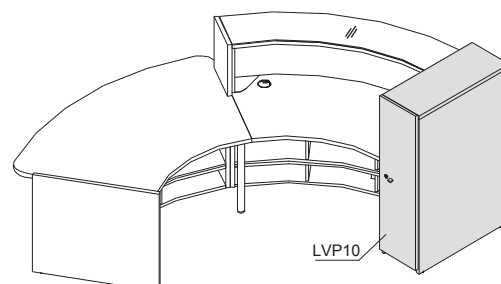

NK41 - Den Fuß zusätzlich zur Verbindung der Thekenelemente bestellen

NK41 - nécessaire sur la connexion des banquettes



PRODUCT ILLUSTRATION OBJEKTANSICHT UND SKIZZE VUE DE PRODUIT	DIMENSIONS / ABMESSUNGEN / DIMENSIONS (mm)			INDEX / SYMBOL	REMARKS BEMERKUNGEN REMARQUES
	width/Breite/ largeur a / a'	depth/Tiefe/ profondeur b / b'	height/Höhe/ hauteur h		



COMMON ELEMENTS / ERGÄNZUNGSELEMENTE / ACCESOIRES

	140	70	750	S81	- vertical cable duct - Kabelführung (Wirbelsäule) - goulotte
	498	228	112	E30	- cable tray - zum Kabelbefestigung unter der Tischplatte - goulotte horizontale

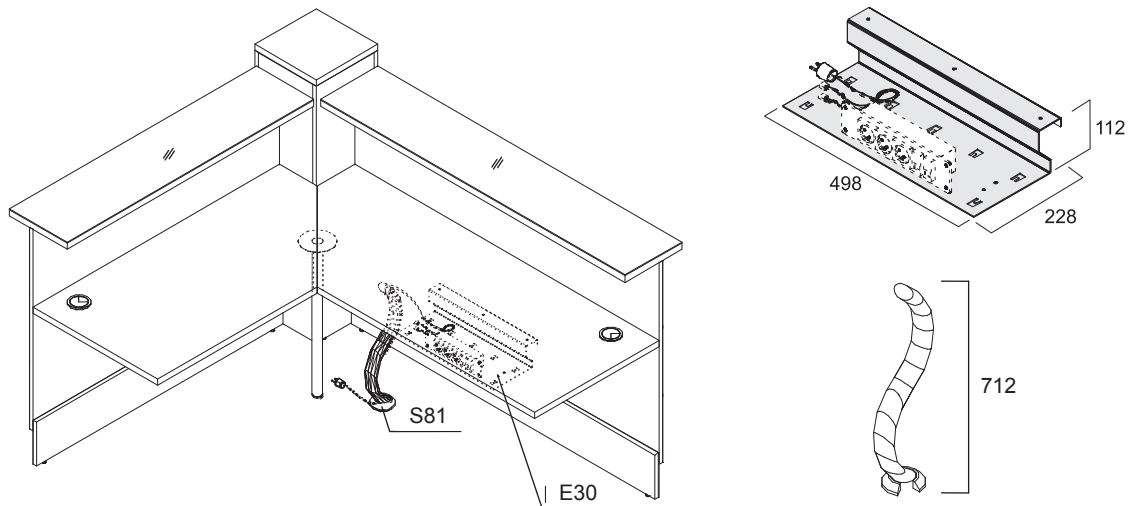

POSSIBLE CONFIGURATIONS / BEISPIEL ANOGDUNG / EXEMPLES DE CONFIGURATIONS

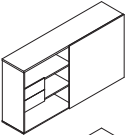
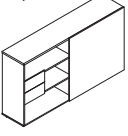

CABINET / SCHRÄNK / RANGEMENT



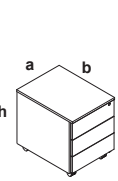



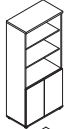

	2000	434	1129	ZS02	- front: HPL, HPL - Front, front stratifié
	2000	434	1129	ZS03	- front: MFC - Front: Melaminplatte - front: panneau mélaminé
	428	385	403	ZSZ01	ZIG-ZAG: - drawer - Schubladen - tiroir

PEDESTAL / CONTAINER / CAISSON



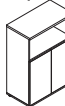

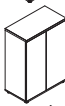

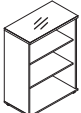

	470	616	580	SLK13	- include pencil case - mit Materialauszug - avec le plumier 67 - white pastel Weiß pastell Blanc pastel
	470	616	580	SLK12	- include pencil case, one filing drawer - Aktenschublade, mit Materialauszug - avec DS., avec le plumier

PRODUCT ILLUSTRATION OBJEKTANSICHT UND SKIZZE VUE DE PRODUIT	DIMENSIONS / ABMESSUNGEN / DIMENSIONS (mm)			INDEX / SYMBOL
	width/Breite/ largeur a / a'	depth/Tiefe/ profondeur b / b'	height/Höhe/ hauteur h	

**STORAGES WITH HPL FRONT / SCHRÄNKE MIT HPL FRONT
/ ARMOIRES AVEC DES FACADES EN STRATIFIE**

		800	432	1833	A5404H
		800	432	1833	A5104H
		800	432	1129	A3404H
		800	432	1129	A3104H
		800	432	777	A2104H

**STORAGES WITH HPL FRONT AND GLASS TOP / SCHRÄNKE MIT HPL FRONT UND
OBERKRANZ MIT GLAS ARMOIRES AVEC DES FACADES EN STRATIFIE
ET TOPS EN VERRE**

		800	432	1134	A3504G
		800	432	1134	A3404HG
		800	432	1134	A3104HG
		800	432	782	A2504G
		800	432	782	A2104HG
<ul style="list-style-type: none"> - MFC + glass - Melaminplatte + Glas - panneau mélaminé + verre 		800	432	33	A800GT



These storages do not have locks.

Ohne Verschluss im Standard.

Armoires ne sont pas équipées d'une serrure.